

ALVEUS

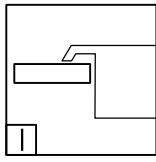

CRYSTALIX WAVE

GLASSIX KARAT

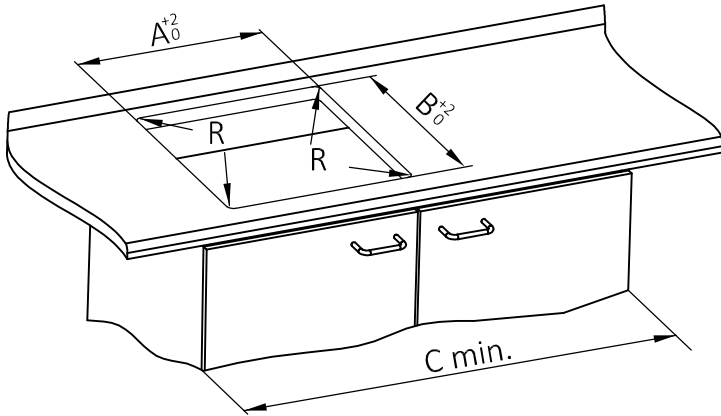
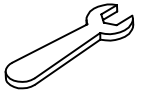

	A [mm]	B [mm]	R [mm]	C [mm]
CRYSTALIX 10 - (860x540)	380	505	10	400
CRYSTALIX 20 - (860x540)	605	505	10	800
GLASSIX 10 - (860x500)	390	461	10	450
GLASSIX 20 - (860x500)	576	451	10	600
GLASSIX 40 - (860x500)	550	451	10	600
WAVE 10 - (620x500)	450	450	130	450
WAVE 20 - (760x500)	450	450	130	450
WAVE 30 - (760x500)	575	450	130	600
KARAT 10 - (860x500)	440	470	10	500
KARAT 20 - (860x500)	610	470	10	800

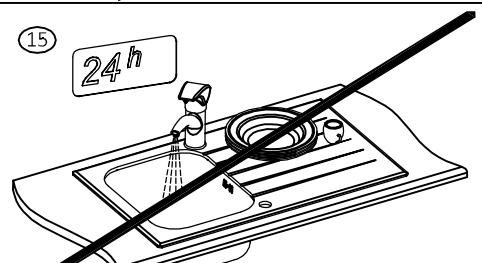
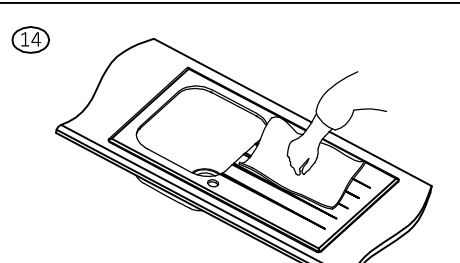
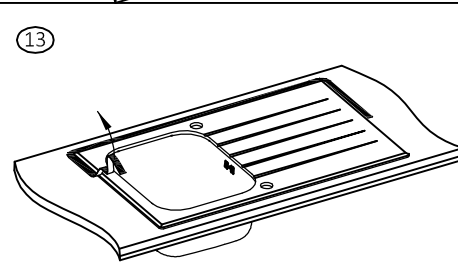
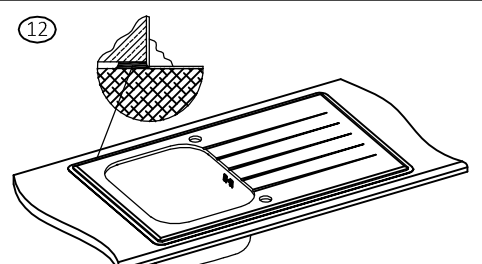
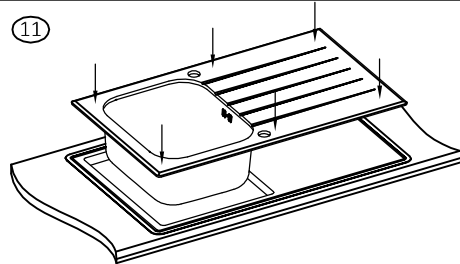
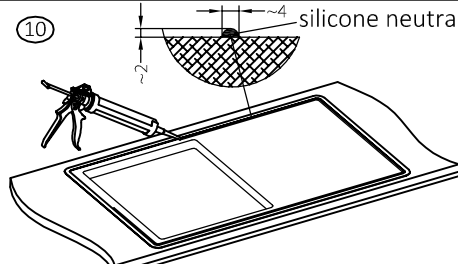
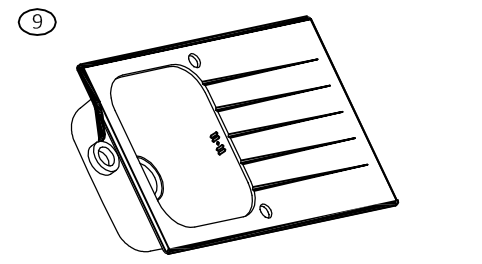
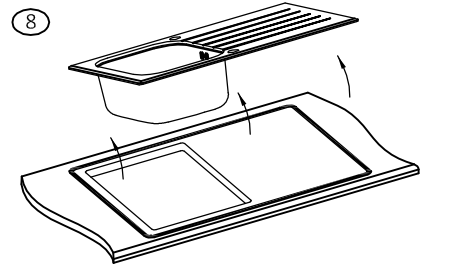
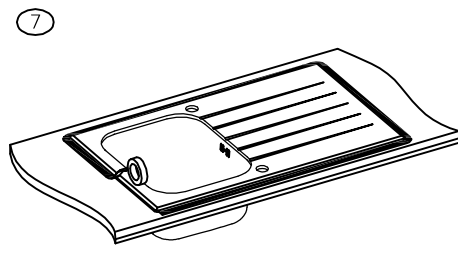
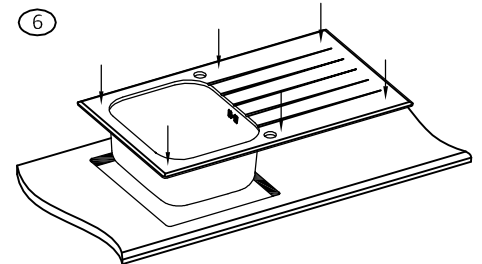
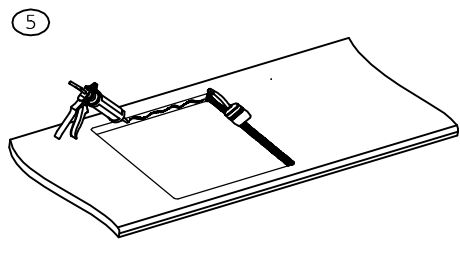
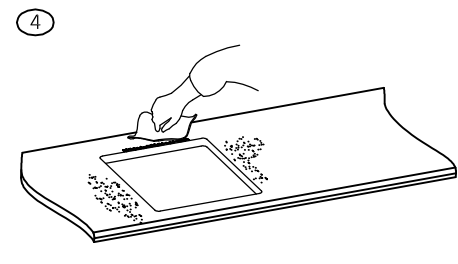
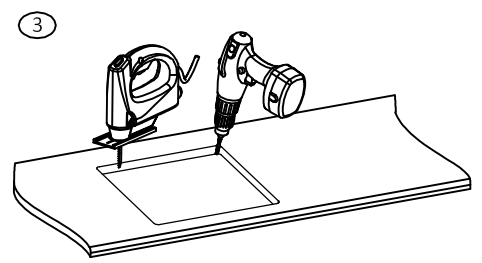
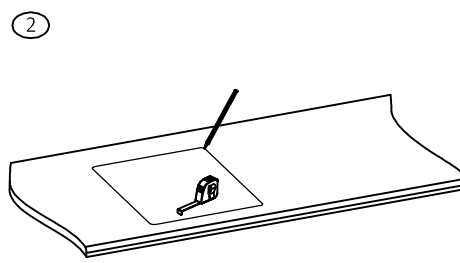
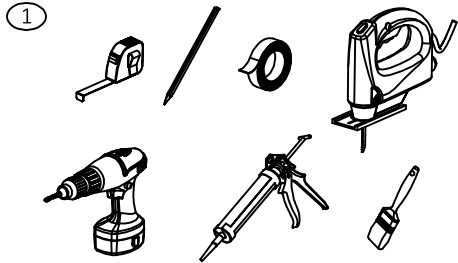

ALVEUS

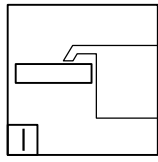

CRYSTALIX WAVE

GLASSIX KARAT



www.alveus.si

	C_{min} [mm]	X_{max} [mm]	Y_{max} [mm]	Z [mm]
CRYSTALIX 10 - (860x540)	400	43	473	27
CRYSTALIX 20 - (860x540)	800	43	245	27
GLASSIX 10 - (860x500)	450	50	435	35
GLASSIX 20 - (860x500)	600	46	260	30
GLASSIX 40 - (860x500)	600	46	279	31
WAVE 10 - (620X500)	450	40	208	29
WAVE 20 - (760X500)	450	40	348	29
WAVE 30 - (760X500)	600	40	160	29
KARAT 10 - (860x500)	500	44	395	25
KARAT 20 - (860x500)	800	44	251	21

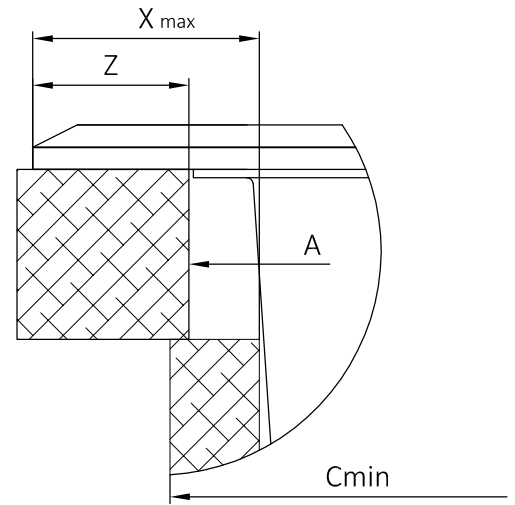

Crystalix 10

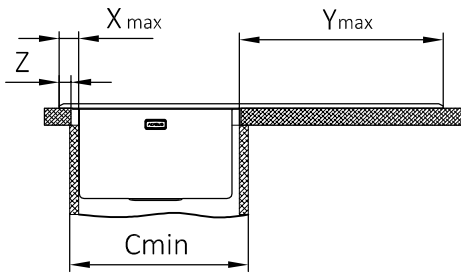

Crystalix 20

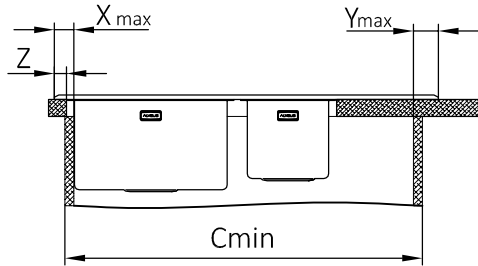

Glassix 10

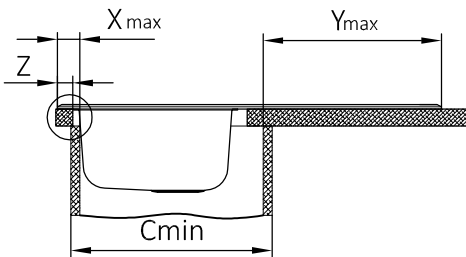

Glassix 20

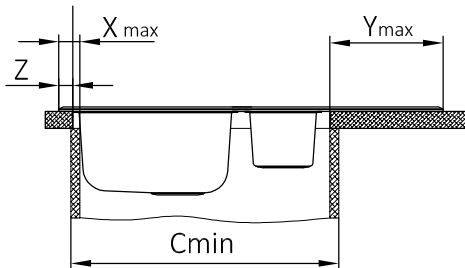

Glassix 40

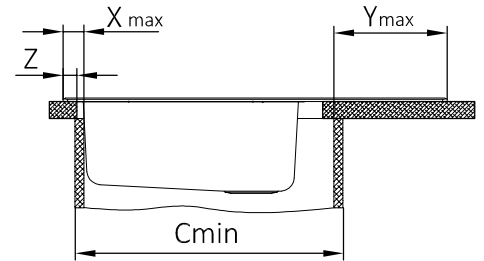

Wave 10

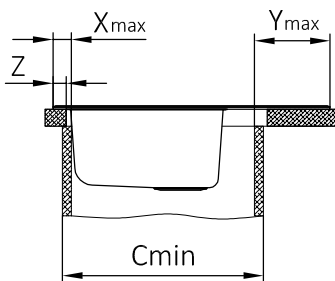

Wave 20

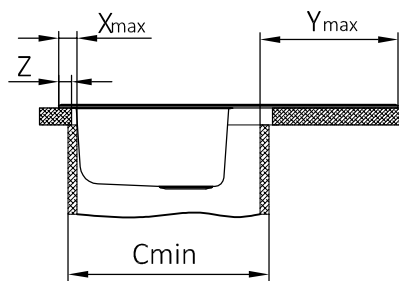

Wave 30

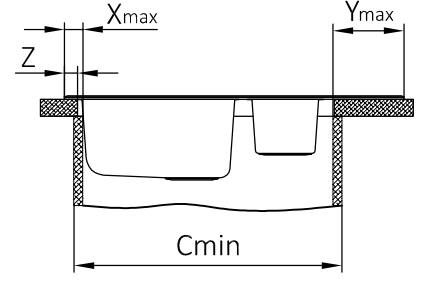

Karat 10

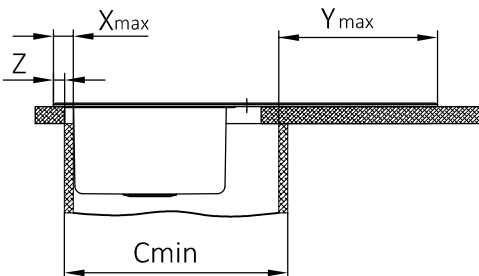

Karat 20

